

## IEG1-21478-2

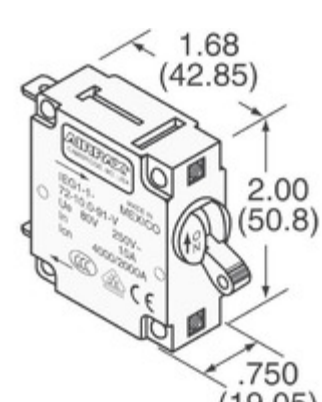

Obrázky jsou pouze orientační.  
Podrobné informace o produktu naleznete v části Technické údaje produktu.  
**Koupit IEG1-21478-2 s důvěrou od Component-World.HK, 1 rok záruka**



**Part Number:** [IEG1-21478-2](#)  
**Výrobce:** [Sensata Technologies, Airpax](#)  
**Popis:** CIR BRKR MAG-HYDR LEVER  
**Datový list:** [IEG, IUG, JEG, CEG, LEG Series Datasheet](#)

**RoHS Status:** Bez olova / V souladu RoHS  
**Ship From:** Hong Kong  
**Shipment Way:** DHL/Fedex/TNT/UPS/EMS

[Request For Quotation](#)







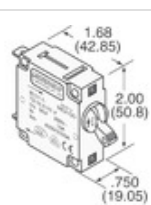
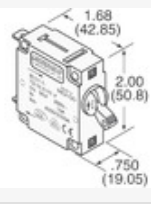
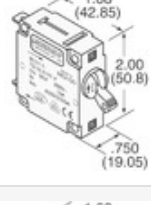

### PARAMETR PRODUKTU

<b>Part Number</b>	IEG1-21478-2	<b>Výrobce</b>	<a href="#">Sensata Technologies, Airpax</a>
<b>Popis</b>	CIR BRKR MAG-HYDR LEVER	<b>Stav volného vedení / RoHS</b>	Bez olova / V souladu RoHS
<b>Dostupné množství</b>	2942 pcs	<b>Datový list</b>	<a href="#">IAG,IUG,JEG,CEG,LEG Series Datasheet</a>
<b>Kategorie</b>	<a href="#">Ochrana obvodu</a>	<b>Série</b>	IEG
<b>Počet pólů</b>	1	<b>Typ montáže</b>	Panel Mount
<b>Úroveň citlivosti na vlhkost (MSL)</b>	1 (Unlimited)	<b>Výrobní standardní doba výroby</b>	6 Weeks
<b>Stav volného vedení / RoHS</b>	Lead free / RoHS Compliant	<b>Osvětlení napětí (nominální)</b>	-
<b>Osvětlení</b>	-	<b>Jmenovitá hodnota proudu</b>	-
<b>Breaker Typ</b>	Magnetic (Hydraulic Delay)	<b>Pohon Type</b>	Lever

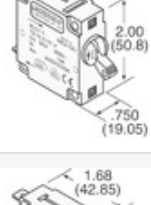
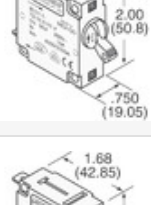
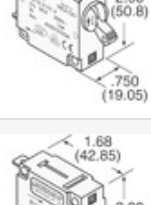
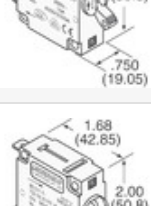
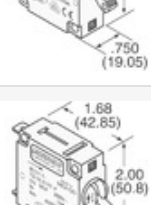
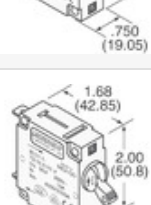
Component-World.com je spolehlivý distributor elektronických součástek. Specializujeme se na všechny elektronické komponenty řady Sensata Technologies, Airpax. Máme 2942 kusy Sensata Technologies, Airpax IEG1-21478-2 na skladě dostupných. Vyžádejte si citát z distributora součástí elektroniky na Component-World.com, náš prodejní tým vás bude kontaktovat do 24 hodin.

RFQ Email: [info@Components-World.com](mailto:info@Components-World.com)

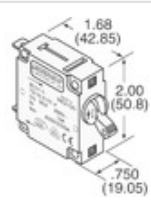
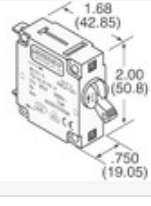
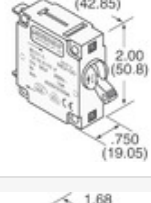
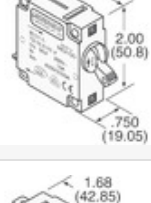
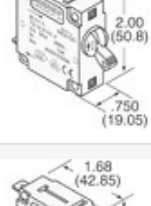
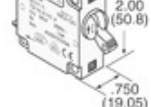
### SOUVISEJÍCÍ PRODUKTY

	<b>Část#:</b> <a href="#">IEG1-1REC5-69-1.00-31-V</a> <b>Popis:</b> CIR BRKR MAG-HYDR	<b>Výrobci:</b> <a href="#">Sensata Technologies, Airpax</a>	<a href="#">Dotaz</a>
	<b>Část#:</b> <a href="#">IEG1-1REC5-69-500-31-V</a> <b>Popis:</b> CIR BRKR MAG-HYDR	<b>Výrobci:</b> <a href="#">Sensata Technologies, Airpax</a>	<a href="#">Dotaz</a>
	<b>Část#:</b> <a href="#">IEG1-1REG4-51-10.0-A-01-V</a> <b>Popis:</b> CIR BRKR MAG-HYDR	<b>Výrobci:</b> <a href="#">Sensata Technologies, Airpax</a>	<a href="#">Dotaz</a>
	<b>Část#:</b> <a href="#">IEG1-30624-1-V</a> <b>Popis:</b> CIR BRKR MAG-HYDR LEVER	<b>Výrobci:</b> <a href="#">Sensata Technologies, Airpax</a>	<a href="#">Dotaz</a>
	<b>Část#:</b> <a href="#">IEG1-1REG4-51-2.00-A-01-V</a> <b>Popis:</b> CIR BRKR MAG-HYDR	<b>Výrobci:</b> <a href="#">Sensata Technologies, Airpax</a>	<a href="#">Dotaz</a>
	<b>Část#:</b> <a href="#">IEG1-30021-1-V</a> <b>Popis:</b> CIR BRKR MAG-HYDR LEVER	<b>Výrobci:</b> <a href="#">Sensata Technologies, Airpax</a>	<a href="#">Dotaz</a>
	<b>Část#:</b> <a href="#">IEG1-29230-2-V</a> <b>Popis:</b> CIR BRKR MAG-HYDR LEVER	<b>Výrobci:</b> <a href="#">Sensata Technologies, Airpax</a>	<a href="#">Dotaz</a>
	<b>Část#:</b> <a href="#">IEG1-29230-1-V</a> <b>Popis:</b> CIR BRKR MAG-HYDR LEVER	<b>Výrobci:</b> <a href="#">Sensata Technologies, Airpax</a>	<a href="#">Dotaz</a>
	<b>Část#:</b> <a href="#">IEG1-30240-15-V</a> <b>Popis:</b> CIR BRKR MAG-HYDR LEVER	<b>Výrobci:</b> <a href="#">Sensata Technologies, Airpax</a>	<a href="#">Dotaz</a>
	<b>Část#:</b> <a href="#">IEG1-29230-3-V</a> <b>Popis:</b> CIR BRKR MAG-HYDR LEVER	<b>Výrobci:</b> <a href="#">Sensata Technologies, Airpax</a>	<a href="#">Dotaz</a>
	<b>Část#:</b> <a href="#">IEG1-1REG4-26371-6-V</a> <b>Popis:</b> CIR BRKR MAG-HYDR LEVER	<b>Výrobci:</b> <a href="#">Sensata Technologies, Airpax</a>	<a href="#">Dotaz</a>
	<b>Část#:</b> <a href="#">IEG1-29628-1-V</a> <b>Popis:</b> CIR BRKR MAG-HYDR LEVER	<b>Výrobci:</b> <a href="#">Sensata Technologies, Airpax</a>	<a href="#">Dotaz</a>
	<b>Část#:</b> <a href="#">IEG1-26078-5-V</a> <b>Popis:</b> CIR BRKR MAG-HYDR LEVER	<b>Výrobci:</b> <a href="#">Sensata Technologies, Airpax</a>	<a href="#">Dotaz</a>
	<b>Část#:</b> <a href="#">IEG1-1REC5-62-250-91-V</a> <b>Popis:</b> CIR BRKR MAG-HYDR	<b>Výrobci:</b> <a href="#">Sensata Technologies, Airpax</a>	<a href="#">Dotaz</a>
	<b>Část#:</b> <a href="#">IEG1-26078-1-V</a> <b>Popis:</b> CIR BRKR MAG-HYDR LEVER	<b>Výrobci:</b> <a href="#">Sensata Technologies, Airpax</a>	<a href="#">Dotaz</a>
	<b>Část#:</b> <a href="#">IEG1-1REG4-35887-15-V</a> <b>Popis:</b> CIR BRKR MAG-HYDR LEVER	<b>Výrobci:</b> <a href="#">Sensata Technologies, Airpax</a>	<a href="#">Dotaz</a>
	<b>Část#:</b> <a href="#">IEG1-1REC5-69-500-31-UV</a> <b>Popis:</b> CIR BRKR MAG-HYDR 500MA LEVER	<b>Výrobci:</b> <a href="#">Sensata Technologies, Airpax</a>	<a href="#">Dotaz</a>
	<b>Část#:</b> <a href="#">IEG1-25715-1</a> <b>Popis:</b> CIR BRKR MAG-HYDR LEVER	<b>Výrobci:</b> <a href="#">Sensata Technologies, Airpax</a>	<a href="#">Dotaz</a>
	<b>Část#:</b> <a href="#">IEG1-1REC5-69-100-21-V</a> <b>Popis:</b> CIR BRKR MAG-HYDR	<b>Výrobci:</b> <a href="#">Sensata Technologies, Airpax</a>	<a href="#">Dotaz</a>
	<b>Část#:</b> <a href="#">IEG1-1REG4-51-20.0-A-01-V</a> <b>Popis:</b> CIR BRKR MAG-HYDR	<b>Výrobci:</b> <a href="#">Sensata Technologies, Airpax</a>	<a href="#">Dotaz</a>

### Související klíčová slova pro IEG1-21478-2

Sensata Technologies, Airpax IEG1-21478-2.	IEG1-21478-2 distributor	IEG1-21478-2 dodavatel	IEG1-21478-2 Cena
IEG1-21478-2 Stáhnout datasheet.	IEG1-21478-2 Datasheet.	IEG1-21478-2 Stock.	koupit IEG1-21478-2.
Sensata Technologies, Airpax IEG1-21478-2.	Sensata Technologies/Airpax IEG1-21478-2.		